



Fire Fighter II National Certification

Certification Preparation Guide

Referenced to:

NFPA 1001, Level 2, 2019 Edition
IFSTA Essentials of Firefighting, 7th Edition

This Study Guide is provided at no cost to the user by the Kansas Fire & Rescue Training Institute as a service to the fire fighters of Kansas.

Copyright © by the Kansas Fire & Rescue Training Institute, University of Kansas. This document is provided for use under the following provisions:

1. Duplication is permitted if the document is duplicated in its entirety, including cover, without editorial changes.
2. No other cover or information is attached as part of the document.



Dear Certification Candidate,

Welcome to the National Fire Fighter Certification Program! Congratulations on completing your course of study and preparation for the National Certification process. You are embarking on a journey that will prepare you to better serve your community. Furthering your firefighting education is one of the best ways ensure that you, your coworkers, and your community are safe. You've done a good job so far. Good luck on your exams!

The Kansas Fire & Rescue Training Institute is accredited by the International Fire Service Accreditation Congress (IFSAC) and by the National Board on Fire Service Professional Qualifications (NBFSPQ - also known as "Pro Board"). These accreditation agencies establish rules and standards to follow in the administration, recordkeeping, and providing of National Certification for the fire service. Through this accreditation, Kansas Fire & Rescue Training Institute is authorized to issue accredited National Certifications to individuals meeting the requirements of selected national standards.

Kansas Fire & Rescue Training Institute's role in the process is to maintain exam materials and provide a fair and accessible system of administering certification exams.

This National Certification Preparation Guide was specifically designed to help you prepare for the testing process ahead. This guide gives reading references for the written exam and the skills exam but please remember that you should read all the materials provided in your course and you may need to read the material more than once. The National Certification process will assess your ability to analyze information, think critically, and apply this knowledge in the performance of practical skills. All exam material is developed according to the Job Performance Requirements (JPRs) found in NFPA 1002, 2017. When in doubt, always go back to the Standard.

Good luck,

KFRTI Staff

(Page Intentionally Left Blank)

National Certification

National Certification is a professional credential that verifies your proficiency in the level to which you were/are certified. National Certifications earned in Kansas do not expire. If you are moving to another state, you should contact the certification entity in that state to find out if your National Certification from Kansas is recognized in that state.

Certification Program Mission

This mission of the National Certification Program is to maintain an accredited system for Kansas fire service members to earn National Fire Service Certification professional credentials.

Certification Program Values and Principles

In the conduct of this program, the Kansas Fire & Rescue Training Institute uses the values listed below to guide our professional conduct; they form the foundations and parameters of this program.

- ✘ We hold in high regard honesty and integrity in ourselves and those we serve.
- ✘ Kindness and professionalism guide our instructors and our evaluators.
- ✘ We respect the fire and emergency service and those who serve in it.
- ✘ Transparency of our system, processes, and policies is paramount.
- ✘ The certification standards drive fair evaluation and testing.
- ✘ We value our role as the provider and protector of the national certification program's credibility.

Academic Accommodation

KU provides accommodations for certification candidates in compliance with the Americans with Disabilities Act. Documentation of the diagnosis from a qualified professional, and a request for accommodation, should be submitted in writing to the Kansas Fire & Rescue Training Institute Certification Manager at least two weeks prior to the exam. The submitted documentation will help KFRTI identify appropriate accommodations. The two-week advanced notice/request allows the Institute to assemble the resources necessary for the accommodation.

Academic Integrity

We hold staff (including part-time) and certification candidates to identical ethical standards. We expect professional behavior at all times. Any incident of academic misconduct by a candidate will invalidate their exam results, forfeit their certification fee, and may subject them to suspension from the certification process for one year.

Academic misconduct includes cheating, plagiarism, falsification of records, unauthorized possession of examinations, intimidation, and/or other actions that may improperly affect the evaluation of a candidate or assisting others in any such act.

Our policy on academic misconduct is that of "zero tolerance."

The University of Kansas prohibits discrimination. Specifically, the University of Kansas prohibits discrimination on the basis of race, color, ethnicity, religion, sex, national origin, age, ancestry, disability, status as a veteran, sexual orientation, marital status, parental status, gender identity, gender expression, and genetic information in the University's programs and activities. Retaliation is also prohibited by University policy.

How to Use the Certification Preparation Guide

This National Certification Preparation Guide is specifically designed to help you prepare for the testing process ahead. This guide provides NFPA JPR and reading references for the written exam and the skills exam.

We have included all administrative forms needed by our office to complete your certification. Please complete all forms in appendix A and bring them with you to the test site. We have also included instructions for creating a profile in our system, registering for your exam, and checking your exam results. Please see appendix B for these instructions.

Firefighter II Certification requires the completion of a take home project consisting of a Private Dwelling Fire & Safety Survey and Pre-Incident Survey of a commercial structure. This project is included in Appendix C. Please read the instructions carefully. Neatness counts. If your drawing is not neat enough to understand or your handwriting cannot be read, the project will be return to be corrected.

We have included information in this guide that will help you achieve the professional credential that is Fire Service National Certification. There are a few key elements in preparing for the National Certification Exam. You should take some time between the end of your course and the certification exam to focus on studying for the exam. You should use this Preparation Guide to help focus on the requirements of the National Standard and your study time.

STEP 1: Complete all forms in appendix A. Don't forget to have your Chief or Training Director sign the appropriate forms.

STEP 2: Follow instructions in Appendix B to register for your exam.

STEP 3: Review the Reading Reference pages and Skill Evaluation sheets in this Certification Guide.

- ✘ The Reading Reference pages are arranged by Job Performance Requirements (JPRs), which are determined by the correlating NFPA standard.
- ✘ Take note of the Instructions to the Candidate (grey boxes) on each Skill Sheet. These are the instructions that the evaluator will give to you in each station before you test.
- ✘ Skills sheet references take you back to the reference manual to explain the skill. You will be graded only on those items listed on the skill evaluation sheets. Use these in your practice and exam preparations.

STEP 4: Read & Review, Read & Review, Read & Review, and Practice, Practice, Practice!

- ✘ Don't practice until you do it right; practice until you can't do it wrong!

STEP 5: Get a good night's rest before the exam.

- ✘ You can be tired in any of three ways: Mentally, Physically, and Emotionally. If you are tired in any of these ways, it will make you tired in ALL of them.
- ✘ Save the party for after the exam...get a good night's rest...eat a good breakfast (if you test in the morning)...easy on the sugar and caffeine...and relax!

GOOD LUCK!

Note:

If you are exploring National Certification and haven't taken a course specifically for the level of certification you are seeking, we STRONGLY suggest that you start the process by taking a course. Under certain circumstances, you may challenge some certification exams. Persons who take a course first do much better on the exam. Contact the Kansas Fire & Rescue Training Institute for more information.

Updated 08/2021

National Certification Application & Processes

Steps for Fire fighter II

- Prerequisites:** All candidates are required to have certified for NFPA 1001, Level 1, Fire Fighter I National Certification. Certifications from other entities will be evaluated for reciprocity as per the KFRTI's Reciprocity policy.
- Application:** Applications are required before testing. Please see appendix A.
- Registration for Exams:** Pre-registration is required. Go to the KFRTI online registration point to register and pay certification fee. Instructions can be found in Appendix B. (<https://www.enrole.com/kupce/jsp/index.jsp?categoryId=10019>)
- Certification Fees:** Certification fees must be paid before the exam date. Individuals are required to pay fees online when registering for an exam.
(Organizations may request to be billed; this billing process requires a Department Billing form from that organization stating each candidate's name. To arrange billing, call the KFRTI at 1-866-804-8841. Billing cannot be processed online.)
- Number of Attempts:** Candidates are allowed two attempts per exam per application, and all testing elements must be completed within one year of the first testing activity. Additional testing requires a new application and fee.
- Picture I.D. Required:** A government issued photo I.D. is required at the exam site.

What if I Fail the Exam?

Failure of any required component (not submitting a signed Local verification form, less than 70% on the written exam, less than 100% on the skills exam, corrections needed for FFII Project) constitutes a failed attempt.

- a. Candidates may re-test on any component of the exam (written, skills exams, project) or resubmit an incomplete verification form.
- b. Candidates must register to take a re-test at another exam site. No walk-in testing is allowed. To register for a re-test, call the Institute at (toll free) 866-804-8841.
- c. Candidates are allowed two (2) attempts at the exam. If a candidate fails the exam twice and wishes to take the exam again, a new certification fee payment is required. The new fee will allow the candidate two more attempts at the exam.
- d. The Institute strongly recommends that candidates study and/or seek additional training before attempting the exam for a third attempt.

Time to Complete Certification

Candidates have one year from the date of their first certification activity to complete their certification. Written and skills testing and re-testing, project submission, verification forms, and all other requirements must be completed within that year. Failure to complete the certification within that year will invalidate all previous testing and the candidate will be required to submit a new application, new certification fee payment, and new verification forms. The candidate must also re-test and pass the written and skills exams before being granted national certification.

Fire Fighter II - Steps to Certification

- Complete Fire Fighter 2 coursework and prepare for the exam.
- Create Profile in KU system. This will allow you to register for courses and exams, view exam results on-line, print course completions and transcripts, prints copies of your certifications. (please see Appendix B for instructions for setting up a profile)
- Choose testing location. Fire Fighter 2 Certification requires a 50-question written exam, a hands-on skills exam, and a take home project. The exams are routinely offered at sites throughout the state. Additionally, written exams may be taken at the KFRTI office in Lawrence. Hands-on skills exams are only offered at certification exam sites. You can find a list of scheduled exam sites at <https://kupce.ku.edu/kufire-fire-fighter-certification>
- Register on-line and pay exam fee. Registration must be completed prior to the exam date. On-site registration is not allowed.
- Complete all forms in Appendix A – forms MUST be turned in to Exam Site Coordinator on the day of testing.
 - Fire Fighter II Local Verification & Mask Fit Form - MUST be signed by Fire Chief, Training Chief or Program Director.
 - Live Fire Verification Form - MUST be signed by Fire Chief, Training Chief or Program Director
 - National Certification Application Form – if you are registering for more than one level at this exam site you need only submit one application, please check all levels you are seeking.
- Take written exam
- Take hands-on skills exam
- Complete and return take home project
- All exam results will be posted in your student record 10-20 working days after exam. Instructions for checking exam results on-line can be found in appendix B. You will receive exam results by mail in 15-20 working days after exam.
- If you do not pass any portion of the certification exam you may register for a retest by calling KFRTI at 866-804-8841 (toll free). Written retests may be taken at the KFRTI offices in Lawrence or at a scheduled exam site. Skills exam retests must be taken at a scheduled exam site. You MAY NOT register for a retest on-line.

Kansas Fire & Rescue Training Institute's National Certification Requirements for Fire Fighter II

Self-Contained Breathing Apparatus Mask Fit Exam Compliance

A copy of the required form on which Fit Exam Compliance can be documented can be found in Appendix A.

Fire Fighter II Local Verification Form:

This form verifies requirements that cannot be tested on a written exam and requirements of the standard that are based on local fire department/organization practices and policies. This form can be found in appendix A.

This form documents:

- a. Candidate's SCBA mask fit has been performed. Due to the potentially hazardous atmospheres that fire fighters operate in, SCBA Fit Exam compliance is required as part of the certification process.
- b. The Candidate has successfully demonstrated the JPRs listed in NFPA 1001 – 2019, JPR 5.2.1, Complete a Basic Incident Report.
- c. The Candidate has successfully demonstrated the JPRs listed in NFPA 1001 – 2019, JPR 5.5.2, Present Fire Safety Information to Station Visitors or Small Groups.
- d. The Candidate has successfully demonstrated the JPRs listed in NFPA 1001 – 2019, JPR 5.5.4, Maintain Power Plants, Power Tools, & Lighting Equipment.
- e. The Candidate has successfully demonstrated the JPRs listed in NFPA 1001 – 2019, JPR 5.5.5, Perform Annual Service Test on Fire Hose.

Any incomplete or unsigned verification form submitted by candidate will be returned for corrections or additional information. Corrected forms must be returned to the Institute to receive credit.

Fire Fighter II Certification Exam

Written Exam:

- a. The Fire Fighter II Written Exam includes 50 multiple choice and true/false questions.
- b. Candidates are allowed one (1) hour to complete the exam.
- c. Answer sheets and pencils are provided.
- d. No cell phones, radios, smart watches, or other electronic devices are allowed in the room while an exam is being administered (an exception for radios that allow "on-duty" personnel to receive alarms may be granted under special circumstances).
- e. A 70% minimum score is required to pass the written exam.

Reading Reference/Text

The Fire Fighter II exam is referenced to:

National Certification exam is based on: *Qualifications, 2019 Edition*

*IFSTA Essentials of Firefighting, 7th Edition NFPA
1001 Standard for Fire Fighter Professional
Qualifications*

Written Exam Study Pages

Written exam study pages can be found in IFSTA Essentials of Fire Fighting, Edition 7,
Appendix A, pages 1409-1411

***Fire Fighter II Skills Exam
Study/Preparation Information and Materials***

Fire Fighter I Skills Exam:

- a. The Skills Exam includes individual and team skills. Depending on the skill, candidates will perform individually, or as a member of a team.
- a. Groups of 4 to 6 candidates are formed for the purpose of skills testing. Individual candidates may not pre-select crews or make up crews of their own choosing. Groups (for testing purposes) are appointed by the Exam Coordinator at the exam site.
- b. When performing as a member of a team, evaluation includes both individual performance and performance as a member of the team.
- c. Skills Exams may be tested in scenario groupings. Scenarios can combine 2-3 JPRs as listed on skill sheets. Scenarios will represent real world application of performance skills as they will be performed on the fire ground. Candidates will be tested over 4-6 JPR skills in two or three scenario stations.
- d. You will be given up to two attempts at each station. The two attempts per station make up your first overall attempt at the skills exam.
- e. Skills exams require 100% to pass in all stations.
- f. No same-day skills re-testing allowed.

Time allowed to take exam: The overall exam is not timed; however, individual skills and/or stations may include a maximum/minimum time (consistent with reasonable fire ground time/operations).

Passing Score: Skills exams require 100% on all stations and skills. Up to two attempts will be given for each skill and/or station being tested make up your first attempt at the skills exam.

No cell phones, radios, smart watches, or other electronic devices are allowed while a skills exam is being administered (an exception for radios that allow “on-duty” personnel to receive alarms may be granted under special circumstances).

Reading Reference/Text

The Fire Fighter II exam is referenced to: *IFSTA Essentials of Firefighting, 7th Edition*

National Standard exam is based on: *NFPA 1001 Standard for Fire Fighter Professional Qualifications, 2019 Edition*

Additional Skills References: *IFSTA Skills Sheets*
KFRTI Skills Evaluation Sheets

Fire Fighter II Skill Evaluation Sheets

These Skills Evaluation Sheets are the exact grading sheets that evaluators use during the Skills Test. These sheets have been edited for the explicit use of grading skills and should not be used to learn the skills.

These Skills Evaluation Sheets have been included in this Preparation Guide for the purpose of guiding you as final preparations are made (and practice performed) for the Qualification Exam.

Grading for the Skills Evaluation requires 100% of the steps listed on the sheet be performed. You will not be evaluated on skills that are not listed on these evaluation sheets.

(Left Page Blank Intentionally)



Fire Fighter II Skills Set: Incident Management System & Communications

Item1

Reference: NFPA 1001, 2019 Edition, Chapter 6, Job Performance Requirement 5.1.2 and 5.2.2
IFSTA, Essentials of Fire Fighting, 7th Edition, 2018, Skill Sheet 19-II-1 (p. 929)
KFRTI, Fire Fighter II Skill Sheets, 2020, Skill Sheet 19-II-1

Evaluator Equipment Required: None

Candidate Equipment: Complete NFPA-Compliant Personal Protective Clothing Ensemble

Evaluator's Instructions to Candidates

At this station, you will be required to implement an Incident Management System (IMS) and communicate the need for team assistance, given a tactical scenario, a set of resources, and a specific assigned role. I will act as the in-coming Commander to whom you will eventually transfer command.

This is a timed event. Expect to complete skill(s) in 3 minutes. To pass this station you must successfully complete 100% of the steps.

Evaluated Skill Items

Establish Incident Command and Coordinate Interior Attack of a Structure Fire

1. Size up incident scene on arrival.
2. Transmit initial report over radio.
3. Establish Incident Command.
4. Identify incident objectives and strategies.
5. Request additional resources as required.
6. Provide briefing to senior officer who is assuming command.
7. Function in assigned role in the IMS.



Reference: NFPA 1001, 2019 Edition, Chapter 5, Job Performance Requirement 5.2.1 IFSTA, Essentials of Fire Fighting, 7th Edition, 2018, Skill Sheet 19-II-2 (p. 930)KFRTI, Fire Fighter II Skill Sheets, 2020, Skill Sheet 19-II-2

Evaluator Equipment Required: Scenario, blank forms, writing instruments, reference documents

Candidate Equipment: None

Evaluator's Instructions to Candidates

At this station, you will be required to complete an Incident Report given a written scenario.

This is a timed event. Expect to complete skill(s) in 5 minutes.

To pass this station you must successfully complete 100% of the steps.

Evaluated Skill Items

Establish Incident Command and Coordinate Interior Attack of a Structure Fire

1. Gather notes and other information on the incident.
2. Record information on incident report form used by the department.
3. Review incident report and make corrections, or revisions as needed.
4. Finalize and process report according to department policy.



Reference: NFPA 1001, 2019 Edition, Chapter 5, Job Performance Requirement 5.3.1IFSTA, Essentials of Fire Fighting, 7th Edition, 2018, Skill Sheet 18-II-2 (p. 893) KFRTI, Fire Fighter II Skill Sheets, 2020, Skill Sheet 18-II-2

Evaluator Equipment Required: Simulated liquid fire, foam concentrate, foam proportioner, water supply, attack line, fire department pumper

Candidate Equipment: NFPA compliant PPE, SCBA, Pass Device, Hand-held radio

Evaluator's Instructions to Candidates

At this station, given foam concentrates, a foam proportioning device, water supply, and an attack line, you will be required to operate as a member of a team to extinguish an ignitable liquid fire.

You must select the proper type of foam concentrate for the burning fuel, assemble foam stream components, and then apply the foam stream on the surface of the fuel to create and maintain an effective foam blanket to extinguish the fire and prevent re-ignition. You will function as the nozzle operator and I will direct which foam application techniques that you will use.

Your team must maintain a foam stream for protection and continue facing the hazard while retreating to a safe haven.

This is a timed event. Expected time to complete skill(s) is 10 minutes. To pass this station, you must successfully complete 100% of the steps.

Evaluated Skill Items

Create an Incident Report

1. Confirm order with Incident Commander (IC) to extinguish fire.
2. Size up scene for hazards (fire conditions, type of fuel, wind conditions).
3. Verify foam type and concentration are appropriate for fuel and fire conditions.
4. Verify attack line is functioning and ready for attack.
5. Extend hose line to point of fire attack (upwind and uphill, able to apply stream).
6. Extinguish fire by applying foam solution as directed (rain, bank, roll on).
7. Maintain situational awareness.
8. Report to Officer completion of assigned task.



Fire Fighter II Skills Set: Coordinate Interior Attack of a Structure Fire **Item 4**

Reference: NFPA 1001, 2019 Edition, Chapter 5, Job Performance Requirement 5.3.2 IFSTA, Essentials of Fire Fighting, 7th Edition, 2018, Skill Sheet 19-II-1 (p. 929) KFRTI, Fire Fighter II Skill Sheets, 2020, Skill Sheet 19-II-1

Evaluator Equipment Required: Fire attack line, forcible entry tools, water supply, fire department pumper. NFPA compliant PPE, SCBA, Pass Device, Hand-held radio

Candidate Equipment: NFPA compliant PPE, SCBA, Pass Device, Hand-held radio

Evaluator's Instructions to Candidates

At this station, given an attack line, forcible entry tools, and a simulated interior fire, you will be required to operate as a member of a team to coordinate an interior fire attack assignment.

You will be required to evaluate fire growth and development, utilize correct attack techniques, communicate plan of attack to team members, and establish and maintain team integrity. You must also choose appropriate tools for forcible entry.

You will also be responsible for incorporating/managing search and rescue and ventilation procedures.

You must recognize developing or hazardous building conditions, report hazards to attack team members and appraise the Incident Commander of changing conditions. I will act as the Incident Commander.

This is a timed event. Expected time to complete skill(s) is 20 minutes. To pass this station, you must successfully complete 100% of the steps.

Evaluated Skill Items

Coordinate Interior Attack of a Structure Fire

1. Assemble & brief team.
2. Correct attack techniques selected for given fire.
3. Evaluate & forecast fire's growth and development.
4. Select appropriate tools for forcible entry.
5. Incorporate search and rescue procedures into fire attack.
6. Incorporate ventilation procedures into fire attack.
7. Determine developing hazardous building or fire conditions.



Fire Fighter II Skills Set: Control a Pressurized Flammable Gas Container Fire

Item 5

Reference: NFPA 1001, 2019 Edition, Chapter 5, Job Performance Requirement 5.3.3 IFSTA, Essentials of Firefighting, 7th Edition, © 2018IFSTA Firefighter II Skill Sheets, Skill Sheet 18-II-3 (p.896)

Evaluator Equipment Required: Simulated flammable gas cylinder fire, fire attack line, water supply line, fire department pumper

Candidate Equipment: NFPA compliant PPE, SCBA, Pass Device, Hand-held radio

Evaluator's Instructions to Candidates

At this station, given an attack line and a simulated gas cylinder fire, you will operate as the leader of a team to control a flammable gas cylinder fire outside a structure. You will direct the application of water using the appropriate technique. You must constantly evaluate the cylinder's integrity as well as changes in condition.

The team must approach and retreat while facing the cylinder and remaining behind protective fire streams.

You must operate fuel control valves to shut off the leaking fuel and ensure that you do not extinguish the flames until leaking gas is eliminated.

This is a timed event. Expected time to complete skill(s) is 7 minutes. To pass this station, you must successfully complete 100% of the steps.

Evaluated Skill Items

Control a Pressurized Flammable Gas Container Fire

1. While wearing appropriate PPE, confirm order with officer to extinguish fire.
2. Size up incident scene for hazards (fire conditions, type of fuel, integrity of container).
3. Deploy handlines (bleed air from hoselines, ensure adequate hoseline to reach fire).
4. Cool cylinder or storage tank
5. Extend hoselines to isolate control valve – Uphill and Upwind, push flame away from valve with fog Stream (30 degree pattern)
6. Maintain situational awareness.
7. Close control valve (shut valve completely, report to officer that valve is closed).



Reference: NFPA 1001, 2019 Edition, Chapter 5, Job Performance Requirement 5.3.4 IFSTA, Essentials of Fire Fighting, 7th Edition, 2018, Skill Sheet 20-II-1 (p.955)

Evaluator Equipment Required: Photographs of a burn scene, scenario, appropriate containers, barrier tape.

Candidate Equipment: Helmet, Safety Glasses, Safety Boots

Evaluator's Instructions to Candidates

At this station, given a burn scenario (or photographs of a burn scenario), you will be required to protect evidence of fire cause and origin. You will be responsible for verbalizing to me anything that you cannot physically complete.

After observing the burn area (or photographs), you must state the possible fire cause and area of origin. You must be able to explain to me why you came to that conclusion or determination.

If you are unable to physically protect the evidence, you must verbalize to me how evidence would be protected until an investigator arrives.

This is a timed event. Expected time to complete skill(s) is 5 minutes. To pass this station, you must successfully complete 100% of the steps.

Evaluated Skill Items

Protect Evidence of Fire Cause and Origin

1. Protect potential evidence (avoid touching, disturbing, or trampling evidence; avoid using excessive water during extinguishment; leave evidence in place) .Size up incident scene for hazards (fire conditions, type of fuel, integrity of container).
2. Preserve evidence as necessary (move evidence only as necessary to preserve it; provide security for the evidence until an investigator is available).
3. Move evidence as necessary (avoid damage to evidence; provide security for the evidence until an investigator is available).
4. Record information about evidence (document information about location and appearance of evidence if it must be moved or cannot be preserved; document location evidence was moved to and the appearance of the location it was moved from; initiate chain of custody record).
5. Provide evidence and records to investigator before leaving incident site.



Fire Fighter II Skills Set: Extricate a Victim Entrapped in a Motor Vehicle

Item 7

Reference: NFPA 1001, 2019 Edition, Chapter 5, Job Performance Requirement 5.4.1 IFSTA, Essentials of Firefighting, 7th Edition, © 2018 IFSTA Firefighter II Skill Sheets, Skill Sheets 17-II-1, 2, 3, 4, 5, 6, 7, 8, and 9

Evaluator Equipment Required: Salvaged automobile, rescue tools, blocking/cribbing material, rescue manikin Vehicles must have gas tanks and batteries removed.

Candidate Equipment: Complete NFPA-compliant PPE without SCBA

Evaluator's Instructions to Candidates

At this station, given a simulated motor vehicle accident with an entrapped victim, stabilization equipment, and extrication tools, operating as a member of a team, you will be required to extricate the victim and assist with rescue operations.

You will be required to conduct a scene size up, establish safety barriers, assess the need for extrication, determine the condition of vehicle, and identify extrication tasks.

The vehicle must be stabilized and you must appropriately deal with supplementary restraint systems. The victim must be accessed, assessed and protected. The victim must be disentangled without further injury using appropriate tools and techniques.

This is a timed event. Expected time to complete skill(s) is 10 minutes. To pass this station, you must successfully complete 100% of the steps.

Evaluated Skill Items

Extricate a Victim Entrapped in a Motor Vehicle

1. Safely operated hand and power tools.
2. Stabilized vehicle using wheel chocks, cribbing, lifting jacks, ropes and webbing, or used a buttress tension system to stabilize a side-resting vehicle.
3. Removed a windshield in an older vehicle.
4. Removed a tempered glass side or rear window.
5. Removed a roof from an upright vehicle or a vehicle on its side.
6. Displaced the dashboard.
7. Supplemental restraint systems assessed and dealt with appropriately.
8. Victim appropriately protected throughout extrication operation.



Reference: NFPA 1001, 2019 Edition, Chapter 5, Job Performance Requirement 5.4.2 IFSTA, Essentials of Firefighting, 7th Edition, © 2018 IFSTA Firefighter II Skill Sheets, Skill Sheets 17-II-1

Evaluator Equipment Required: Rescue tools and equipment, barrier tape, and cones.

Candidate Equipment: Complete NFPA-compliant PPE without SCBA

Evaluator's Instructions to Candidates

At this station, you will be required to assist a rescue operation team. You will be directed by me to accomplish various tasks commensurate to the level of training required of a Level II Firefighter.

This is a timed event. Expected time to complete skill(s) is 10 minutes. To pass this station, you must successfully complete 100% of the steps.

Evaluated Skill Items

Assist Rescue Operation Teams

1. Identified and retrieved correct tools and equipment as directed.
2. Established public safety barriers.
3. Assisted rescue team as an assigned member.



Fire Fighter II Skills Set: Maintain Power Plants, Power Tools, and Lighting Equipment

Item 9

Reference: NFPA 1001, 2019 Edition, Chapter 5, Job Performance Requirement 5.5.4 IFSTA, Essentials of Firefighting, 7th Edition, © 2018IFSTA Firefighter II Skill Sheets, Skill Sheets 21-II-1 and 21-II-2

Evaluator Equipment Required: Power Plant, lighting equipment, power cords, power tools (saws, extrication power unit), maintenance hand tools, and equipment instruction manuals.

Candidate Equipment: None

Evaluator's Instructions to Candidates

At this station, given power plants, lighting equipment, and power tools, you will be required to check for damage, test for function, and perform operator-level maintenance per the manufacturer's instructions.

You must ensure the tool or equipment is clean and functional, any corrective actions required are completed, and identify any equipment that is non-operational and cannot be further corrected at the operator-level of maintenance.

This is a timed event. Expected time to complete skill(s) is 7 minutes. To pass this station, you must successfully complete 100% of the steps.

Evaluated Skill Items

Maintain Power Plants, Power Tools, and Lighting Equipment.

1. Reviewed the manufacturer's service manual for specific directions.
2. Checked spark plugs for damage, visible corrosion, carbon accumulation, or cracks.
3. Checked carburetor and identify signs of fuel leaks.
4. Checked fuel level and refueled as needed.
5. Checked oil level and refilled as needed.
6. Started power unit and ran tests as required by the service manual.
7. Inspected all electrical cords for damage (insulation tears, exposed wiring, prongs).
8. Tested operation of lighting equipment by connecting all lights one at a time and replaced bulbs as necessary; discarding faulty bulbs in an approved manner.
9. Cleaned work area and returned all tools and equipment to the proper storage areas.
10. Documented maintenance on the appropriate forms or records.



Reference: NFPA 1001, 2019 Edition, Chapter 5, Job Performance Requirement 5.5.5 IFSTA, Essentials of Firefighting, 7th edition, © 2018IFSTA Firefighter II Skill Sheets, Skill Sheets 21-II-3

Evaluator Equipment Required: Fire Dept pumper, fire hose, spanner wrenches, marking device, watch, water source, and fire nozzles.

Candidate Equipment: NFPA Compliant PPE without SCBA.

Evaluator's Instructions to Candidates

At this station, you will be required to perform an annual service test on a given set of fire hose. While you will not be required to operate the pumper, you must direct the pump operator as appropriate.

This is a timed event. Expected time to complete skill(s) is 15 minutes. To pass this station, you must successfully complete 100% of the steps.

Evaluated Skill Items

Service Test Fire Hose.

1. Visually inspected and evaluated hose for possible damage.
2. Checked and marked couplings for damage, function, and gaskets.
3. Connected fire hose in lengths not to exceed 300 ft per line, to fire dept pumper.
4. Tightened couplings and marked hose at the couplings for slippage.
5. Attached nozzle to the hose and the other end to a gated discharge on the pumper.
6. Filled hoseline slowly with nozzle open to release air then close.
7. Checked all hoselines for leaks, kinks, and twists. Fixed as needed.
8. Per NFPA 1962, instructed pump operator to raise pressure to appropriate test pressure for five minutes.
9. Checked hoselines for leakage and observed coupling for hose slippage.
10. Slowly dropped pump pressure, shut gate valve on pumper and opened nozzle.
11. Recorded test results for each section of hose.

Appendix A

Local Verification Form

National Certification Application Form

(Left Page Blank Intentionally)

Fire Fighter II

Local Verification & Mask Fit Form

NFPA 1001 – 2019

Candidate's Name: _____ Date of Birth: _____

Local Verification Requirements

1. **29 CFR 1910.134, Mask Fit Documentation:** The candidate has been successfully fitted to his or her Self-Contained Breathing Apparatus (SCBA) Mask in compliance with 29 CFR 1910.134 within the last twelve (12) calendar months.

1. **NFPA 1001 – 2019, JPR 5.2.1, Complete a Basic Incident Report:**

The candidate has successfully demonstrated the ability to operate department computers and other ancillary equipment to complete basic incident reports.

2. **NFPA 1001 – 2019, JPR 5.5.2, Present Fire Safety Information to Station Visitors or Small Groups:**

The candidate has successfully demonstrated the ability to successfully use prepared materials in presenting safety information to station visitors or small groups and then document these presentations in department records.

3. **NFPA 1001 – 2019, JPR 5.5.4, Maintain Power Plants, Power Tools, & Lighting Equipment:**

The candidate has successfully demonstrated the ability to successfully complete departmental equipment maintenance records and comply with departmental maintenance reporting procedures.

4. **NFPA 1001 – 2019, JPR 5.5.5, Perform Annual Service Test on Fire Hose:**

The candidate has successfully demonstrated the ability to successfully complete departmental equipment maintenance records for annual service testing of fire hose.

***This section is to be completed and signed by
Fire Chief, Training Chief, or Program Director ONLY***

I have reviewed the candidate's file and affirm that the candidate identified above has met the requirements listed in items 1-4 above. All requirements have been successfully conducted and completed per local department protocol and policies. All information listed above can be validated by a written and/or hard copy of the documents maintained by the department.

Typed or Legibly Printed Name of Fire Chief, Training Chief, or Program Director

Signature of Fire Chief, Training Chief, or Program Director

Date: _____ Department / Organization: _____

Department / Organization Phone Number: (_____) _____ - _____

(Page Intentionally Left Blank)

**NFPA 1001 FIRE SUPPRESSION VERIFICATION FORM
FIRE FIGHTER I, FIRE FIGHTER II**

This Fire Suppression Verification Form, **fully and accurately completed**, shall be administered as part of the Kansas Fire & Rescue Training Institute Certification process to indicate the Certification Candidate has met the Job Performance Requirements (JPRs) for the specified objectives for NFPA 1001, *Standard for Fire Fighter Professional Qualifications, 2019 Edition*.

(Please Print Legibly):

Last Name _____ First Name _____ MI _____

Name of Fire Department / Organization _____

Birthdate _____

INSTRUCTIONS: Complete the appropriate section(s) below based on the Certification Candidate's intended level of training and certification.

Fire Fighter I Local Verification

Objective #	Job Performance Requirement	Auditor's Initials	Date
JPR# 4.3.10	Interior Structural Fire Attack - FF1 Interior Attack, Nozzle, Ops		
JPR# 4.3.7	Passenger Vehicle Fire Attack - FF1 Car Fire		
JPR# 4.3.8	Exterior Class A Fire Attack - FF1 Fire Attack Class A		

Fire Fighter II Local Verification

Objective #	Job Performance Requirement	Auditor's Initials	Date
JPR# 5.3.2	Coordination of Interior Fire Attack - FF2 Fire Attack		

This form is NOT valid without the signature of the Department Fire Chief, Training Chief, Fire Science Community College Program Director, or other Designee.

Affirmation of Signers: This is to attest that the Certification Candidate named above has successfully completed all Job Performance Requirements (JPRs) for each respective Fire Suppression Evolution, during formal training conducted in accordance with NFPA 1403, *Live Fire Training Evolutions, 2018 edition*.

Department Fire Chief, Training Chief, Fire Science Community College Program Director, or other Designee:

Print Name _____ Signature _____ Date _____

(Left Page Blank Intentionally)

Appendix B

How to Set up a Profile

How to View Your Results Online

(Page Intentionally Left Blank)

Click on the hyperlink below

<https://www.enrole.com/kupce/jsp/>

Then click on
“Create Profile/Sign In”

The screenshot shows the KU Professional & Continuing Education website. At the top, there is a blue header with the KU logo, the text 'Professional & Continuing Education Courses & Events Directory', and a search bar with 'Email address' and 'Enter password' fields, a 'SIGN IN' button, and a 'Cart (0)' icon. Below the header is a yellow banner with the text: 'New look, same great programs and support! As you can see, the KU Professional & Continuing Education website is updated with a new design and features. Take a look around, and if you have any questions or feedback, email us at kupce@ku.edu or call us at 877-404-5823.'

The main content area is titled 'Courses Home' and features a search bar labeled 'Search courses'. On the left side, there is a navigation menu with the following items: 'KUPCE Courses Home', 'Search by Instructor', 'Shopping Cart', and 'Create Profile / Sign In'. The 'Create Profile / Sign In' item is circled in red, and a red arrow points from the text 'Then click on "Create Profile/Sign In"' to this item. Below these items is a list of categories: 'Aerospace', 'Conferences', 'Engineering', 'Fire & Rescue Training Institute', 'Information Technology', 'Kansas Law Enforcement Training Center', 'Leadership & Management', 'Osher Lifelong Learning Institute', 'Social Sciences', and 'Zero Credit'.

The main content area is titled 'KUPCE Courses & Events Directory' and features a grid of buttons for the following categories: 'Aerospace', 'Conferences', 'Engineering', 'Fire & Rescue Training Institute', 'Information Technology', 'Kansas Law Enforcement Training Center', 'Leadership & Management', 'Osher Lifelong Learning Institute', 'Social Sciences', and 'Zero Credit'.

Below the grid, there is a section titled 'Courses & Events' with a sub-section 'Donation to the Osher Institute'. The text reads: 'Donations to the Osher Institute help support its mission to offer noncredit enrichment courses and activities for folks over 50 years of age.' Below this, it says 'July 27, 2017 to January 22, 2018'.

At the bottom right, it says 'Updated 08/2021'. At the bottom left, there is a link: 'Leadership Link & Learn: Cyber-Security: What Every Leader Needs to Know'.

OR....go to our web page and click...

<http://kupce.ku.edu/kufire-home>

SEE AVAILABLE COURSES

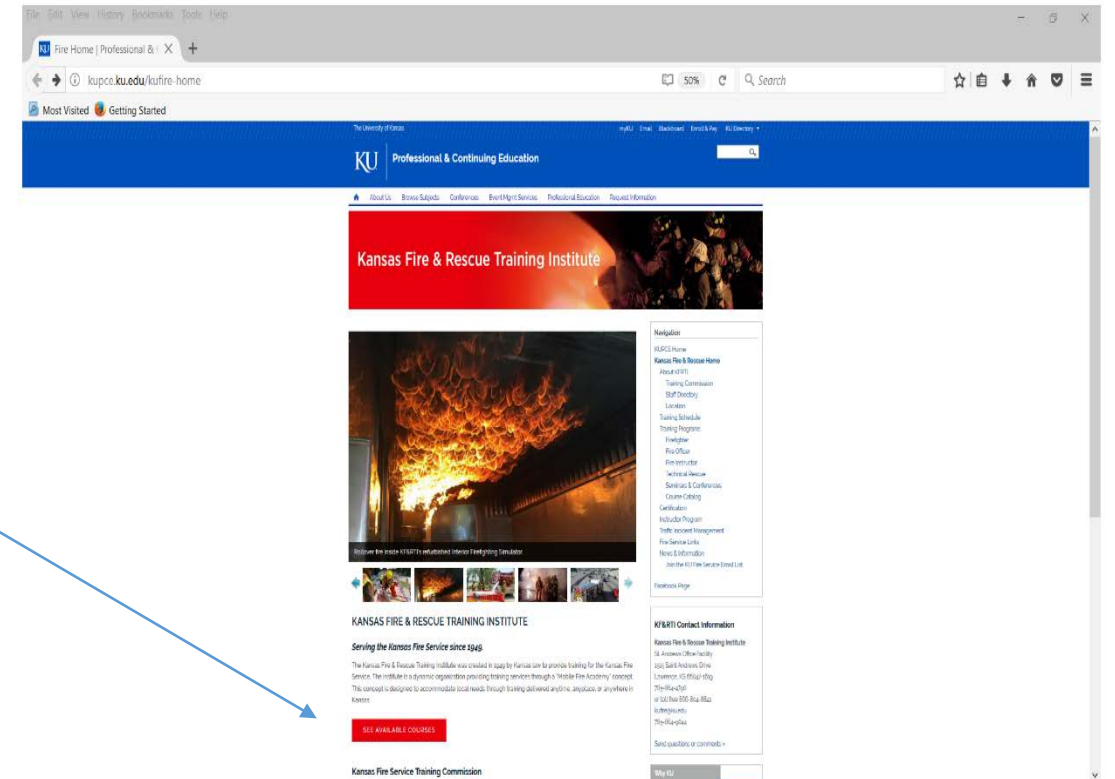

Then click "Create Profile / Sign In"

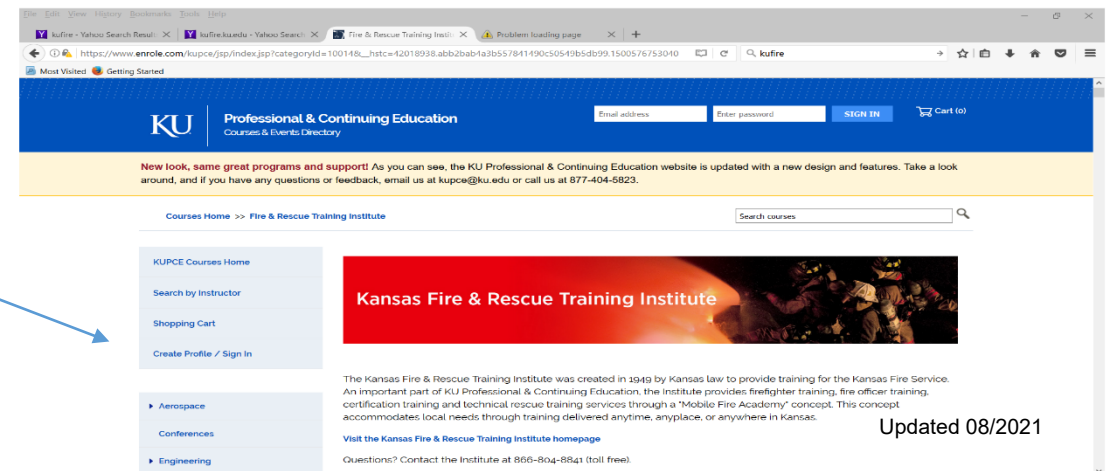

New look, same great programs and support! As you can see, the KU Professional & Continuing Education website is updated with a new design and features. Take a look around, and if you have any questions or feedback, email us at kupce@ku.edu or call us at 877-404-5823.

[Courses Home](#)



[KUPCE Courses Home](#)

[Search by Instructor](#)

[Shopping Cart](#)

[Create Profile / Sign In](#)

Customer Profile / Sign In

Returning Customer

Email:

[Forgot your email?](#)

Password:

[Forgot your password?](#)

SIGN IN

CREATE PROFILE

Important Notes

Please keep your profile information current. In the event of a course change or other emergency, we may need to contact you by phone or email. [Privacy Statement](#). We respect the information visitors give us and do not sell, rent, or loan our subscriber lists to third parties.

If you have already created a profile; sign in with the email and password you selected and skip to page 5

Click on **“Create Profile”**

[Aerospace](#)

[Conferences](#)

[Engineering](#)

[Fire & Rescue Training Institute](#)

[Information Technology](#)

[Kansas Law Enforcement Training Center](#)

[Leadership & Management](#)

[Osher Lifelong Learning Institute](#)

[Social Sciences](#)

[Zero Credit](#)

Fill this page out completely

We have included tips/notes to address frequently asked questions

When complete – click

Submit

The form contains the following fields and sections:

- Navigation:** Shopping Cart, Create Profile / Sign In
- Menu:** Aerospace, Conferences, Engineering, Fire & Rescue Training Institute, Information Technology, Kansas Law Enforcement Training Center, Leadership & Management, Osher Lifelong Learning Institute, Social Sciences, Zero Credit
- Registration Fields:**
 - Email address: * (jummis@ku.edu)
 - Verify email address: *
 - First name: *
 - Middle name:
 - Last name: *
 - Suffix:
 - Date of birth: *
 - Job Title:
 - SID Cert Number:
 - Address: *
 - City: *
 - State/Province: *
 - Kansas County: *
 - Other State/Province:
 - Zip/Postal Code: *
 - Country: *
 - Preferred phone:
 - Alternate phone:
 - Password: *
 - Re-Type password: *
 - Security question: *
 - Security answer: *
 - Re-type answer: *
- Interests:** Please select your personal interests
 - Big Data & Business Analytics
 - Engineering
 - Industrial Technology
 - Information Technology
 - Leadership & Management
 - Other Enrichment Education
 - Social Sciences
- Organization Information:** Please provide the following organization information
 - I am NOT affiliated with a company or organization
 - Organization - Dept. name: *
 - Address: *
 - City: *
 - State/Province: *
 - Other State/Province:
 - Kansas County: *
 - Zip/Postal Code: *
 - Country: *
 - Company phone:

TIP: If you have more than 1 email address choose the one you use most often. This will be your UserID and where all communications will be sent.

NOTE: Please enter your HOME address

NOTE: This is where your Fire Department information is entered. If you work for more than 1 department choose your fulltime department.

Submit (circled in red)

- You are now ready to “shop” for classes.

- To see available courses click on “Fire & Rescue Training Institute”

The screenshot shows the KU Professional & Continuing Education website. The top navigation bar is blue with the KU logo, the text "Professional & Continuing Education Courses & Events Directory", the user name "Hello, Joliene Lummis", and a shopping cart icon labeled "Cart (0)". Below the navigation bar is a yellow banner with the text: "New look, same great programs and support! As you can see, the KU Professional & Continuing Education website is updated with a new design and features. Take a look around, and if you have any questions or feedback, email us at kupce@ku.edu or call us at 877-404-5823." The main content area is white and features a "Courses Home" link and a search bar labeled "Search courses". On the left side, there is a vertical menu with the following items: "KUPCE Courses Home", "Search by Instructor", "Shopping Cart", "Order History", "My Profile", and "Logout". Below this menu is a list of categories: "Aerospace", "Conferences", "Engineering", "Fire & Rescue Training Institute", "Information Technology", and "Kansas Law Enforcement Training Center". The "Fire & Rescue Training Institute" category is circled in red, and a red arrow points from the text in the second bullet point to this category. On the right side, there is an "Attendee List" section showing "Joliene Lummis (jlummis@ku.edu)" with a red 'x' icon. Below that is a "Shopping cart" section with the message "You have no items in your shopping cart" and two buttons: "Continue shopping" and "Add attendee".

New look, same great programs and support! As you can see, the KU Professional & Continuing Education website is updated with a new design and features. Take a look around, and if you have any questions or feedback, email us at kupce@ku.edu or call us at 877-404-5823.

[Courses Home](#) >> [Fire & Rescue Training Institute](#)

[KUPCE Courses Home](#)

[Search by Instructor](#)

[Shopping Cart](#)

[Order History](#)

[My Profile](#)

[Logout](#)

▸ [Aerospace](#)

[Conferences](#)

▸ [Engineering](#)

▾ [Fire & Rescue Training Institute](#)

[Fire Instructor](#)

[Fire Officer Training](#)

[Firefighter Training](#)

[National Firefighter Certification](#)

[Seminars & Conferences](#)

[Technical Rescue Training](#)

[Traffic Incident Management Program](#)

▸ [Information Technology](#)

▸ [Kansas Law Enforcement Training Center](#)

▸ [Leadership & Management](#)

▸ [Osher Lifelong Learning Institute](#)

[Social Sciences](#)

▸ [Zero Credit](#)



Kansas Fire & Rescue Training Institute

The Kansas Fire & Rescue Training Institute was created in 1949 by Kansas law to provide training for the Kansas Fire Service. An important part of KU Professional & Continuing Education, the Institute provides firefighter training, fire officer training, certification training and technical rescue training services through a 'Mobile Fire Academy' concept. This concept accommodates local needs through training delivered anytime, anyplace, or anywhere in Kansas.

[Visit the Kansas Fire & Rescue Training Institute homepage](#)

Questions? Contact the Institute at 866-804-8841 (toll free).

[Fire Instructor](#)

[Fire Officer Training](#)

[Firefighter Training](#)

[National Firefighter Certification](#)

[Seminars & Conferences](#)

[Technical Rescue Training](#)

Courses & Events

[Aircraft Rescue and Firefighting: Annual Training](#)

This course is designed to provide airport firefighters with an opportunity to refresh their aircraft firefighting and rescue skills and meets or exceeds FAA requirements for "live-fire drill" as listed in FAA Part 139.319(j)(3).

This course contains no sessions

[Click here to be notified about the next scheduled program.](#)

[Alternative Fuel Vehicles](#)

This course covers Alternative Fuel Vehicle (AFV) safety and incident response.

Sunday, August 27, 2017, El Dorado Fire Dept

Scroll down to find the course you are interested in

This course contains no sessions

[Click here to be notified about the next scheduled program.](#)

- **Find your course**

Driving Simulator Training

This training utilizes simulators to reinforce good driving skills and mediate the correct response to a driving situation.

Friday, August 25, 2017, Fairmount Twp Fire Dept

(1 seats (6%) remaining)

Saturday, August 26, 2017, Fairmount Twp Fire Dept

Sunday, August 27, 2017, Fairmount Twp Fire Dept

Friday, September 15, 2017, Andover Fire and Rescue

Saturday, September 16, 2017, Andover Fire and Rescue

Sunday, September 17, 2017, Andover Fire and Rescue

Friday, September 22, 2017, El Dorado Fire Dept Stat 2

Saturday, September 23, 2017, El Dorado Fire Dept Stat 2

Sunday, September 24, 2017, El Dorado Fire Dept Stat 2

Friday, October 6, 2017, Shawnee Height Fire Dist Stat 23

Saturday, October 7, 2017, Shawnee Height Fire Dist Stat 23

Sunday, October 8, 2017, Shawnee Height Fire Dist Stat 23

Thursday, November 2, 2017, Emporia Fire Dept

Friday, November 3, 2017, Emporia Fire Dept

Saturday, November 4, 2017, Emporia Fire Dept

- **Click on the course date**

Emergency Vehicle Driver Training - VFIS

Participants in this course will have the opportunity to gain and/or verify a broad range of competencies associated with emergency vehicle driving. These competencies include basic understanding of emergency vehicle operations as well as the skills necessary

Updated 08/2021

New look, same great programs and support! As you can see, the KU Professional & Continuing Education website is updated with a new design and features. Take a look around, and if you have any questions or feedback, email us at kupce@ku.edu or call us at 877-404-6823.

Courses Home >> Fire & Rescue Training Institute >> Firefighter Training

- KUPCE Courses Home
- Search by Instructor
- Shopping Cart
- Order History
- My Profile
- Logout

- Aerospace
- Conferences
- Engineering
- ▾ Fire & Rescue Training Institute
 - Fire Instructor
 - Fire Officer Training
 - Firefighter Training
 - National Firefighter Certification
 - Seminars & Conferences
 - Technical Rescue Training
 - Traffic Incident Management Program
- Information Technology
- Kansas Law Enforcement Training Center
- Leadership & Management
- Osher Lifelong Learning Institute
- Social Sciences
- Zero Credit

Course detail: FSDST - Driving Simulator Training

This training utilizes simulators to reinforce good driving skills and mediate the correct response to a driving situation. Situations are repeatable until the desired skill is learned without endangering students or damaging equipment. The simulator contains all of the functions and controls needed for conducting driver training.

Session Detail: FF18033F

Schedule: Every day, starting on 10/06/17 and ending on 10/06/17

Times: 08:00am - 05:00pm

[View Full Schedule](#) | [Add to my calendar](#)

Price: KS Fire Dept Member : \$0.00

Add-ons

8:00am-10:00am (08:00am-10:00am)

KS Fire Dept Member : \$0.00

1:00pm-3:00pm (01:00pm-03:00pm)

KS Fire Dept Member : \$0.00

3:00pm-5:00pm (03:00pm-05:00pm)

KS Fire Dept Member : \$0.00

Instructors

Name	Additional Resources
Rick Deibert	

Facility Detail

Shawnee Height Fire Dist Stat 23
5301 SE California
Topeka, KS 66609

[Add to Cart](#)

• If required, choose the time you want to attend the course.

• Click

Add to cart

Click

Checkout

Note:
If you do not see the “Checkout” button you are not signed on or something went wrong.

Professional & Continuing Education
Courses & Events Directory

Hello, Joliene Lummis  Cart (1)

New look, same great programs and support! As you can see, the KU Professional & Continuing Education website is updated with a new design and features. Take a look around, and if you have any questions or feedback, email us at kupce@ku.edu or call us at 877-404-5823.

Courses Home



KUPCE Courses Home
Search by Instructor
Shopping Cart
Order History
My Profile
Logout

Aerospace
Conferences
Engineering
Fire & Rescue Training Institute
Information Technology
Kansas Law Enforcement Training Center
Leadership & Management
Osher Lifelong Learning Institute
Social Sciences
Zero Credit

Attendee List

Joliene Lummis (jlummis@ku.edu)

Shopping cart

	Unit cost	Discount	Total price	
▶ Driving Simulator Training 10/06/17 - 10/06/17, Shawnee Height Fire Dist Stat 23	\$0.00	\$0.00	\$0.00	
Joliene Lummis x 8:00am-10:00am :	\$0.00	\$0.00	\$0.00	
Joliene Lummis x				

Grand total: \$0.00

There should be a name in both places. If there is not you will need to use the “add attendee” drop down that will appear.

If there is no “Checkout” button you need to check 1 of 2 things –

1. Are you still signed on (if not, sign back in and continuing shopping)
2. Does your name appear under the course name in the shopping cart, if not you will need to use the add attendee drop down. If there is no add attendee drop down than you will need to click continue shopping and try again.

Click

Next

The screenshot shows the top navigation bar of the KU Professional & Continuing Education website. The header includes the KU logo, the text 'Professional & Continuing Education Courses & Events Directory', the user name 'Hello, Jolene Lummis', and a shopping cart icon labeled 'Cart (0)'. Below the header is a yellow banner with a welcome message and contact information. The main content area features a 'Courses Home' link and a search bar. On the left is a vertical menu with options like 'KUPCE Courses Home', 'Search by Instructor', 'Shopping Cart', 'Order History', 'My Profile', 'Logout', 'Aerospace', and 'Conferences'. The 'Billing Information' section contains a 'Promotional Mailing Code' input field, a 'How did you hear about us?' dropdown menu, and two buttons: '< Back' and 'Next >'. The 'Next >' button is circled in red, and a red arrow points from the 'Next' text in the red box on the left to this button.

Review your order

Click

Submit



If you need to make a change click

Cancel



KU Professional & Continuing Education
Courses & Events Directory

Hello, Jolene Lummis 

New look, same great programs and support! As you can see, the KU Professional & Continuing Education website is updated with a new design and features. Take a look around, and if you have any questions or feedback, email us at kupce@ku.edu or call us at 877-404-5823.

Courses Home

KUPCE Courses Home

Search by Instructor

Shopping Cart

Order History

My Profile

Logout

Summary Review

Please confirm your order.

Session	Unit price	Attendees	Discount	Total price
Driving Simulator Training 10/06/17 - 10/06/17 Shawnee Height Fire Dist Stat 23 8:00am-10:00am	\$0.00	Jolene Lummis (14250)	\$0.00	\$0.00
<i>(1 per attendee)</i>				

Total charge: \$0.00

[Cancel](#) [Submit order](#)

- ▶ Aerospace
- Conferences
- ▶ Engineering
- ▶ Fire & Rescue Training Institute
- ▶ Information Technology
- ▶ Kansas Law Enforcement Training Center
- ▶ Leadership & Management

You are enrolled!!

Note:

If you do not see this page your order has not been placed and you are not registered for the course.

The screenshot shows the KU Professional & Continuing Education website. The header includes the KU logo, the text 'Professional & Continuing Education Courses & Events Directory', the user name 'Hello, Jollene Lummis', and a shopping cart icon with '0' items. A yellow banner below the header reads: 'New look, same great programs and support! As you can see, the KU Professional & Continuing Education website is updated with a new design and features. Take a look around, and if you have any questions or feedback, email us at kupce@ku.edu or call us at 877-404-5823.'

The main content area is divided into a left sidebar and a main right section. The sidebar contains navigation links: 'Courses Home', 'Search by Instructor', 'Shopping Cart', 'Order History', 'My Profile', and 'Logout'. Below these are category links with right-pointing arrows: 'Aerospace', 'Conferences', 'Engineering', 'Fire & Rescue Training Institute', 'Information Technology', 'Kansas Law Enforcement Training Center', 'Leadership & Management', and 'Osher Lifelong Learning Institute'.

The main right section features a confirmation message: 'Thank you. Your order has been placed.' Below this is a table with the following data:

Order	Attendee	Session	Fee	Message
15582	Jollene Lummis (14250)	Driving Simulator Training	\$0.00	
15583	Jollene Lummis (14250)	8:00am-10:00am	\$0.00	

Below the table, it states 'Total charge: \$0.00'. Underneath is a section titled 'Based on your selections, you might also be interested in the following courses'. It lists three courses with brief descriptions:

- Fire Officer 1 Training**: This IFSAC Certification course will address NFPA 1021, Standard for Fire Officer Professional Qualifications for Fire Officer 1. The focus is on innovative management, leadership, scene operations, and human relations concepts.
- Alternative Fuel Vehicles**: This course covers Alternative Fuel Vehicle (AFV) safety and incident response.
- Driver/Operator: Pumper Training**: This course will educate driver/operators who are responsible for operating apparatus equipped with fire pumps.

At the bottom of the main section are three buttons: 'Continue shopping' (blue), 'Logout' (blue), and 'Print this page' (red).

You will get an “order confirmation” email that looks like this.

Within 24 business hours you will get a “course confirmation” email with the course Details.

Reply Reply All Forward IM
Fri 8/18/2017 10:30 AM
kupce@ku.edu
Thank you for your order
To Lummis, Joliene

Bing Maps + Get more apps

KU PROFESSIONAL & CONTINUING EDUCATION
The University of Kansas

Order	Attendee	Event	Fee	Message
15582	Joliene Lummis (14250)	Driving Simulator Training Add to my calendar	\$0.00	
15583	Joliene Lummis (14250)	8:00am-10:00am Add to my calendar	\$0.00	

Total Charge: \$0.00

[Edwards Campus
Professional & Continuing Education
Regents Center 125
12600 Quivira Rd.
Overland Park, KS 66213]

We are here to help!!! If you have any questions

- Call us toll free at 866-804-8841
- Email us kufire@ku.edu



Joliene



Erica



Pattie

How To View National Certification Exam Results Online

1. Visit the [KU Lifelong & Professional Education Courses & Events Directory](#) to log-In to your on-line profile.

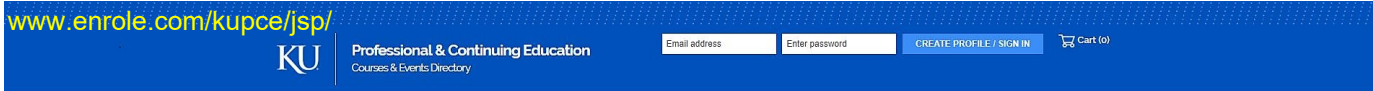

2. Once logged-in navigate to your **Order History**.

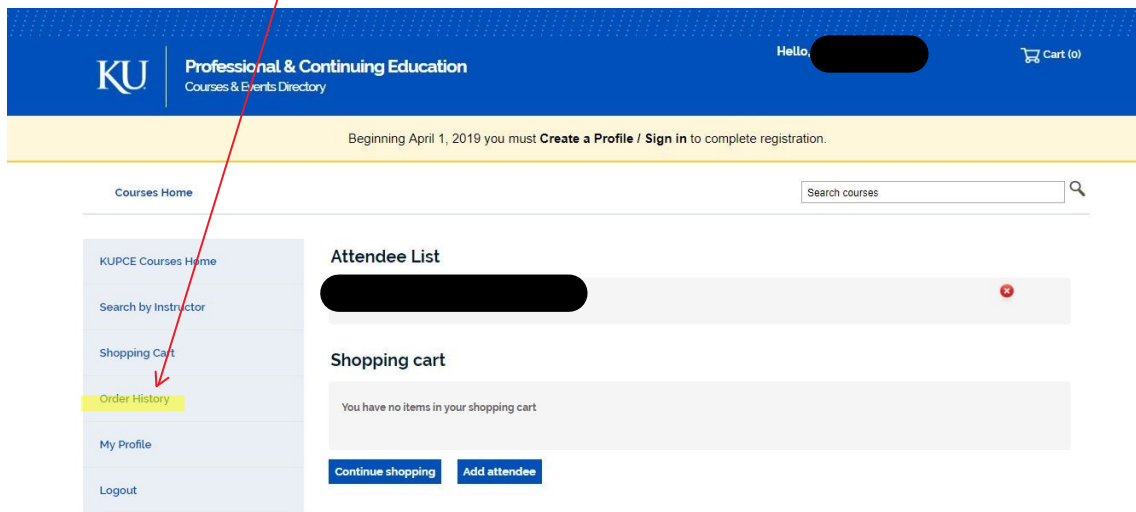

3. Your exam results and certificate will be listed under the applicable class and the related sub-sessions.

The **Certificate** will be available under the main session as a **PDF**.

Practical Skills and Project Exam Scores will be available under the appropriate sub-session and posted next to **Grade** as **PASS** or **FAIL**.

Written Exam Scores will be found by the **CEU value**. A score of 70 and above is passing.

Past Events	
ID: A73B7268	Title: Fire Fighter 2
Ordered on: 04/12/19	Dates: December 8-9, 2017
Status: Registrant's attendance verified	View certificate
Fee: \$0.00	
Balance: \$0.00	
<hr/>	
ID: A73B7269	Title: Fire Fighter 2 - Homework Projects
Ordered on: 04/12/19	Dates: Saturday, December 9, 2017
Status: Registrant's attendance verified	Grade: PASS
Fee: \$0.00	
Balance: \$0.00	
<hr/>	
ID: A73B7650	Title: Fire Fighter 2 - Practical Skills
Ordered on: 04/12/19	Dates: Saturday, December 9, 2017
Status: Registrant's attendance verified	Grade: PASS
Fee: \$0.00	
Balance: \$0.00	
<hr/>	
ID: A73B7651	Title: Fire Fighter 2 - Written Exams
Ordered on: 04/12/19	Dates: Friday, December 8, 2017
Status: Registrant's attendance verified	CEU: 85.00
Fee: \$0.00	
Balance: \$0.00	

Updated 08/2021

Appendix C
Fire Fighter II
Take Home Project

Fire Fighter II

Project Booklet

If you have any questions concerning these submissions, please contact KFRTI at Toll Free 866-804-8841 or by email at kufire@ku.edu .

You may submit this project electronically by scanning and emailing to kufire@ku.edu



Private Dwelling & Fire Safety Survey

Homework Project No. 1
for
Fire Fighter II Certification

Skill Set: Private Dwelling Fire & Safety Survey

OBJECTIVE: NFPA 1001-2019, Chapter 5, Section 5.5.1.

REFERENCE: IFSTA, *Essentials of Fire Fighting*, 7th Edition, ©2019.

Candidate Equipment Required: Private Dwelling Fire & Safety Survey Report, Writing implement.

Evaluator Equipment Required: Project to be submitted to KFRTI for grading.

Task for Candidate

Given a blank Private Dwelling Fire & Safety Survey Report and writing instrument, you will be required to conduct a safety survey of a private dwelling and annotate the Private Dwelling Fire & Safety Survey Report with your findings.

Evaluation Items

You will be evaluated on your skills to complete forms, recognize hazards, match findings to preapproved recommendations, and effectively communicate your findings to occupants or referrals.

Instructions to Candidate

You are to conduct a Private Dwelling Fire & Safety Survey in a private dwelling other than your own. It may be occupied by a relative or friend, but it may not be the residence at which you live.

The residence may be a free-standing house, an apartment, or a condominium.

You **MUST** have permission of the occupant to conduct this survey and the occupant must sign the completed survey. You should leave a copy of the signed & completed form with the occupant.

This is a professional project. It must be neat and legible.

You must use the applicable local ordinances in conducting your survey (open burning, chemical storage, etc.)

You must submit the original signed & completed survey to the Kansas Fire & Rescue Training Institute as part of your certification. It is recommended that you keep a copy in the event that the copy you submit is lost.

You must submit this homework project with a completed Fire Chief's Project Verification form. Failure to do so will result in the homework project being returned to the candidate without action. This form may be found on the last page of the Project Book.

You have 12 calendar months from the date you begin your certification activity (written exam or practical skills) for this homework project to arrive at the Kansas Fire & Rescue Training Institute. Failure to meet this deadline will constitute the failed first of two attempts to successfully complete this project.

This project must be your own original work. Your submission must be neat and your handwriting must be legible. Submissions that do not meet the standard for professional work will be returned for correction and resubmission.



Firefighter II

Certification – Homework Project No. 1 Submission

Private Dwelling Fire & Safety Survey

Candidate Name _____

Candidate Department _____

Location of FFII Course _____

Date Submitted _____ Candidate Phone # _____

Candidate Email _____

Candidate Certification

I certify that the attached project submitted is my own, original work. This submission was prepared in accordance with the guidance given in the KFRTI Firefighter II Certification Preparation Guide.

Candidate Signature _____

Chief Officer/Program Director Verification

I verify that the attached project submitted is the original work of the candidate listed above. This submission was prepared in accordance with the guidance given in the KFRTI Firefighter II Certification Preparation Guide.

Signature _____

Printed Name _____



Pre-Incident Survey

Homework Project No. 2
for
Fire Fighter II Certification

Skill Set: Prepare a Pre-Incident Survey

OBJECTIVE: NFPA 1001-2019, Chapter 5, Section 5.5.3.

REFERENCE: IFSTA, *Essentials of Fire Fighting*, 7th Edition, ©2019.

Candidate Equipment Required: Tape measure(s), sketch paper, pencils, ruler(s)/scale(s), camera (optional), identification, blank Pre-Incident Survey Forms.

Evaluator Equipment Required: Project to be submitted to KFRTI for grading.

Task for Candidate

Given blank Pre-Incident Survey forms and appropriate equipment, you will be required to conduct a Pre-Incident Survey of a:

- (1) commercial occupancy (other than a bank, or general storage facility)
- (2) governmental occupancy (other than a fire station, EMS station, or law enforcement station)
- (3) place of worship, or
- (4) commercial daycare facility and complete the Pre-Incident Survey forms with your findings.

If doing a commercial occupancy in a strip mall or in a typical “downtown city block” (i.e., commercial occupancy with shared party walls), you must do the **entire strip mall** or the **entire city block**.

Evaluation Items

You will be evaluated on your skills to identify the components of fire suppression & detection systems; sketch the site, buildings, & special features; detect hazards & special considerations to include in the pre-incident sketch; and complete all related forms.

Instructions to Candidate

You **MUST** have permission of the occupancy’s owner or manager to conduct this survey and the owner or manager must sign the completed survey. You should leave a copy of the signed & completed form with the owner or manager. You should schedule an appointment with the owner or manager and be on time. Dress and act professionally as you are representing your department and the fire service.

This is a professional project. It must be neat and legible.

It is recommended that the selected occupancy be in your fire department’s assigned response area. You must use the applicable local ordinances in conducting your survey (open burning, chemical storage, etc.)

You must submit the **ORIGINAL** signed & completed survey to KFRTI as part of your certification. It is recommended that you **KEEP A COPY** in the event that the copy you submit is lost.

You must submit this homework project with a completed Fire Chief/Program Director Project Verification form. Failure to do so will result in the homework project being returned to the candidate without action. This form may be found at the end of this Project Book.









You have 12 calendar months from the date you complete the written component of the Fire Fighter II certification program for this homework project to arrive at KFRTI. Failure to meet this deadline will constitute the failed first of two attempts to successfully complete this project.

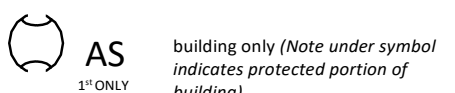
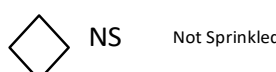

This project must be **YOUR OWN ORIGINAL WORK**. If you have questions, you may ask your instructor for assistance, or call KFRTI Toll Free 866-804-8841 for further assistance.

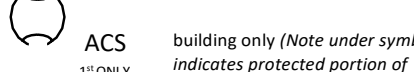
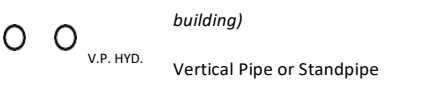
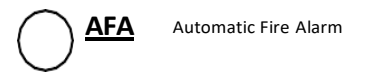
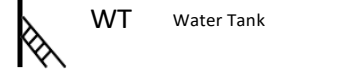
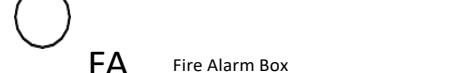
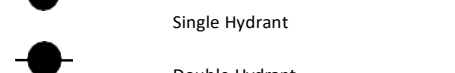
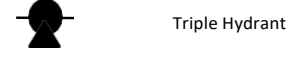
CHECKLIST FOR PREPARING FIELD SKETCHES & REPORT DRAWINGS

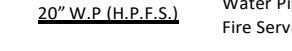
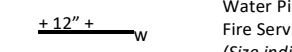

- North pointing arrow.
- Date of survey.
- Building or Business name (if applicable.)
- Building address.
- Owner's or manager's name.
- Name(s) of access streets.
- Property access, parking lot entrances.
- Exposure street numbers, construction, and use.
- Distances to exposures.
- Street water mains and/or location & capacity of nearest hydrant(s). In areas without hydrants please indicate on drawing.
- Building designation (occupancy numbers and/or letters.)
- Dimensions, interior and exterior required on all drawings.
- Windows, doors, and key obstructions.
- Fire walls and blank walls.
- Stairways (open, closed, and emergency.)
- Elevators.
- All utility locations (Interior and Exterior)
- Exterior ornamentation such as marquees, parapets, awnings, and billboards.
- Fire escapes and emergency exits.
- Chimneys and stacks.
- On-site water supplies (size, capacity, source, pump, tank, etc.)
- Underground fuel tanks (and appropriate shutoffs) and septic systems.
- All interior and exterior utility connections, electrical panel, power shut off, hot water heater.
- Low-hanging utility lines that may cause overhead obstructions.
- Areas protected by sprinklers.
- FDC and/or wall hydrants.
- Risers (with sizes) and/or standpipes (with sizes.)
- Building construction type and any modifications made.
- Floor construction.
- Significant under-floor conditions.
- Roof type, support type (truss or stick built), and composition.
- Significant ground slope and access problems.
- Hazardous materials storage & NFPA 704 designation.
- Sectional drawing(s) if appropriate.
- Legend showing any uncommon abbreviations and/or symbols used.
- Show only non-movable building components (e.g., counters, fixed warehouse racks, etc.)

FIRE PROTECTION

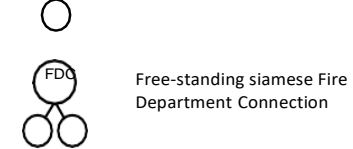
-  4" Sprinkler Riser (Size indicated)
 -  Automatic Sprinklers throughout contiguous sections of single risk
 -  Automatic Sprinklers on all floors of building
 -  Automatic Sprinklers in part of building only (Note under symbol indicates protected portion of building)
 -  1st ONLY Automatic Sprinklers in part of building only (Note under symbol indicates protected portion of building)
 -  NS Not Sprinkled
 -  ACS Automatic Chemical Sprinklers
 -  ACS 1st ONLY Automatic Chemical Sprinklers in part of building only (Note under symbol indicates protected portion of building)
 -  V.P. HYD. Vertical Pipe or Standpipe
 -  AFA Automatic Fire Alarm
 -  WT Water Tank
 -  F.E. Exterior Fire Escape (Plan view only)
 -  FA Fire Alarm Box
 -  Single Hydrant
 -  Double Hydrant
 -  Triple Hydrant
 -  H Dry Hydrant
- 20" W.P. (H.P.F.S.) Water Pipes of the High Pressure Fire Service (Size indicated)
- +12" + W Water Pipes of the High Pressure Fire Service as shown on Key Map (Size indicated)
- 6" W.P. W Public Water Service (Size indicated)

-  FDC Siamese Fire Department Connection (Indicate size if other than 2-1/2")
-  FDC 4" Single 4-inch Fire Department Connection
-  Free-standing siamese Fire Department Connection



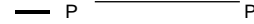

UNDERGROUND UTILITY SERVICE LINES

-  Water line (Size indicated)
-  Sewer line
-  Power line







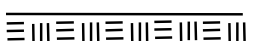









HYDRANT COLOR CODE

- LIGHT BLUE: Class AA – 1,500 gpm or greater
- GREEN: Class A – 1,000 – 1,499 gpm
- ORANGE: Class B – 500 – 999 gpm
- RED: Class C – Less than 500 gpm





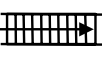

MISCELLANEOUS

-  Utility meter (Type indicated)
-  Electric service panel or fuse box
-  Valve (General)
-  Valve in underground pit
-  OS&Y valve
- 

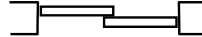
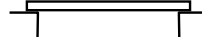
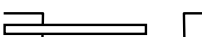
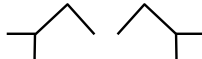

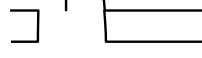
VERTICAL OPENINGS

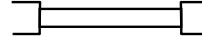
	Skylightlighting top story only
	Skylightlighting 3 stories (Number indicates stories)
	Skylightwith wired glass in metal sash
	Open elevator
	Frame enclosed elevator
	Frame enclosed elevator with traps
	Frame enclosed elevator with self-closing traps
	Concrete block enclosed elevator with traps
	Tile enclosed elevator with self-closing traps
	Brickenclosed elevator with wired glassdoor
	Open hoist
	Hoist with traps
 B. To 1	Open hoist (Basement to 1 st floor)
	Enclosed stairwell with fire door (Plan view only)
	Open stairs (Plan view only)
	Stairs (Elevation view only)

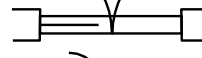
HORIZONTAL OPENINGS

	Sliding bypass doors
	Sliding door
	Pocket door
	Sliding bypass doors
	Sliding bypass doors
	Door (Hinged)
	Overhead door (Roll-up or track indicated)
	Fixed window
	Single double-hung window
	Double double-hung window
	Double casement window
	Casement window

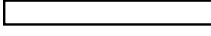
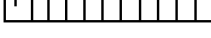
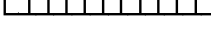
WALL CONSTRUCTION

	Wall (Framed wood or steel)
	Brickwall
	Concrete block wall
	Poured concrete wall

COLOR CODE FOR WALL CONSTRUCTION

BROWN – Fire-resistive protected steel	RED – Brick or hollow tile	YELLOW – Wood frame or stucco
BLUE – Concrete, stone, or hollow concrete block		GRAY – Noncombustible unprotected steel

SITE FEATURES

1. The exterior walls of buildings are outlined in single thickness lines if other than fire-rated, and double thickness if fire-rated.
2. The perimeter of canopies, loading docks, and other open-walled structures are shown by broken lines.

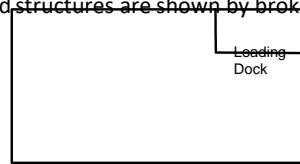

Railroad Tracks. Each track is shown by a single line with crossed dashes.

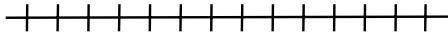

Paved Roads & Streets. Paved roads & streets are shown by two parallel solid lines.



Gravel Roads. Gravel roads are shown by two parallel dashed lines.



Dirt Roads. Dirt roads are shown by two parallel dotted lines.

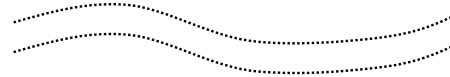

Bodies of Water. Rivers, streams, lakes, ponds, etc., are outlined. Direction of flow is indicated by arrows.

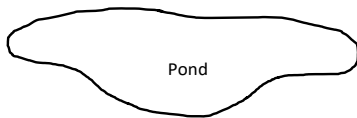

Fences. Fences are shown as lines with "x's" every half-inch. Gates are shown..



Overhead Wires. Low-hanging overhead wires that may cause overhead obstructions are indicated by lines with open circles every half-inch



Property Lines. -----

Fire Department Access. F.D. >

Parking Lots. Parking lots are indicated by type of surface:

Asphalt or concrete



Gravel

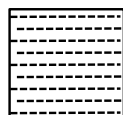

Dirt

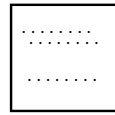

North Arrow.



COMMON ABBREVIATIONS

Above	ABV	Pounds Per Square Inch	PSI
Acetylene	ACET	Pressure	PRESS
Aluminum	AL	Protected Steel	PROT ST
Asbestos	ASB	Private	PRIV
Automatic	AUTO	Public	PUB
Automatic Fire Alarm	AFA	Railroad	RR
Automatic Sprinklers	AS	Reinforced Concrete	RC
Avenue	AVE	Reservoir	RES
Brick	BR	Revolutions Per Minute	RPM
Building	BLDG	Roof	RF
Cast Iron	CI	Room	RM
Cinder Block	CB	Slate Shingle Roof	SSR
Composition Roof	COMPR	South	S
Concrete	CONC	Stainless Steel	SST
Diameter	DIA	Steel	ST
Double Hydrant	DH	Steel Deck	ST DK
East	E	Stone	STONE
Elevator	ELEV	Story	STO
Engine	ENG	Street	STREET
Exhauster	EXH	Stucco	STUC
Feet	FT	Suspended Acoustical Tile Ceiling	SATL
Fire Escape	FE	Tank (<i>Label capacity in gallons</i>)	TK ___ GAL
Fire Department Connection	FDC	Tile Block	TB
Floor	FL	Timber	TMBR
Fuel Oil (<i>Label with grade number</i>)	FO # ___	Tin Clad	TIN CL
Gallon	GAL	Triple Hydrant	TH
Gallons Per Minute	GPM	Truss	TR
Gasoline	GASOLINE	Under	UND
Generator	GEN	Veneer	VEN
Glass	GL	Volts	V
Glass Block	GB	Wall Hydrant	WLH
Gypsum Board (<i>Drywall</i>)	GYP BD	West	W
High Voltage	HV	Wire Glass	WGL
Hose Connection	HC	Wood	WD
Hydrant	HYD	Wood Frame	WD FR
Inch, Inches	IN	Yard	YD
Iron	IR		
Iron Pipe	IP		
Liquid	LIQ		
Liquid Oxygen	LOX		
Manager	MGR		
Manufacturer	MFR		
Manufacturing	MFG		
Maximum Capacity	MAX CAP		
Metal	MT		
Natural Gas	GAS		
Normally Closed	NC		
Normally Open	NO		
North	N		
Number	No		
Outside Screw & Yoke Valve	OS&Y		
Platform	PLATF		
Pound (<i>Unit of force</i>)	LB		



Firefighter II

Certification – Homework Project No. 2 Submission

Pre-Incident Survey

Candidate Name _____
Candidate Department _____
Location of FFII Course _____
Date Submitted _____ Candidate Phone # _____
Candidate Email _____

Candidate Certification

I certify that the attached project submitted is my own, original work. This submission was prepared in accordance with the guidance given in the KFRTI Firefighter II Certification Preparation Guide.

Candidate Signature _____

Chief Officer/Program Director Verification

I verify that the attached project submitted is the original work of the candidate listed above. This submission was prepared in accordance with the guidance given in the KFRTI Firefighter II Certification Preparation Guide.

Signature _____

Printed Name _____

Business Name:	Date:
Address:	

General Information

Emergency Contact
Name _____ Daytime Phone _____ After Hours Phone _____

Occupancy Type:

Construction Type (I, II, III, IV, V)	# of Floors	Year Built	Elevator Y N	Square Footage

Roof Construction:

Fire Protection System:

Location of Fire Escapes:

Location and Capacity of Fire Hydrant OR Other Water Source:
--

Location of Utility Controls:

Exposure Hazards:

Estimated Fire Flow:	Fire Flow GPM = (L x W) / 3
_____ GPM	
25% Involvement (.25 x GPM)	50% Involvement (.5 x GPM)
_____	_____
	75% Involvement (.75 x GPM)

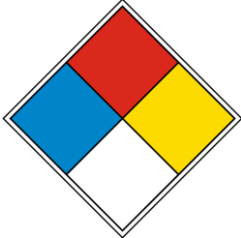
 <p>NFPA 700</p>	Additional Hazards or Watch Conditions:
---	---

OCCUPANCY:
ADDRESS:

DATE:

Page ___ of
___ pages.

Plot Plan

OCCUPANCY:
ADDRESS:

DATE:

Page ___ of
___ pages.

“A” Side Elevation

“B” Side Elevation

OCCUPANCY:
ADDRESS:

DATE:

Page ___ of
___ pages.

“C” Side Elevation

“D” Side Elevation

OCCUPANCY:
ADDRESS:

DATE:

Page ____ of
____ pages.

Basement Floor Plan

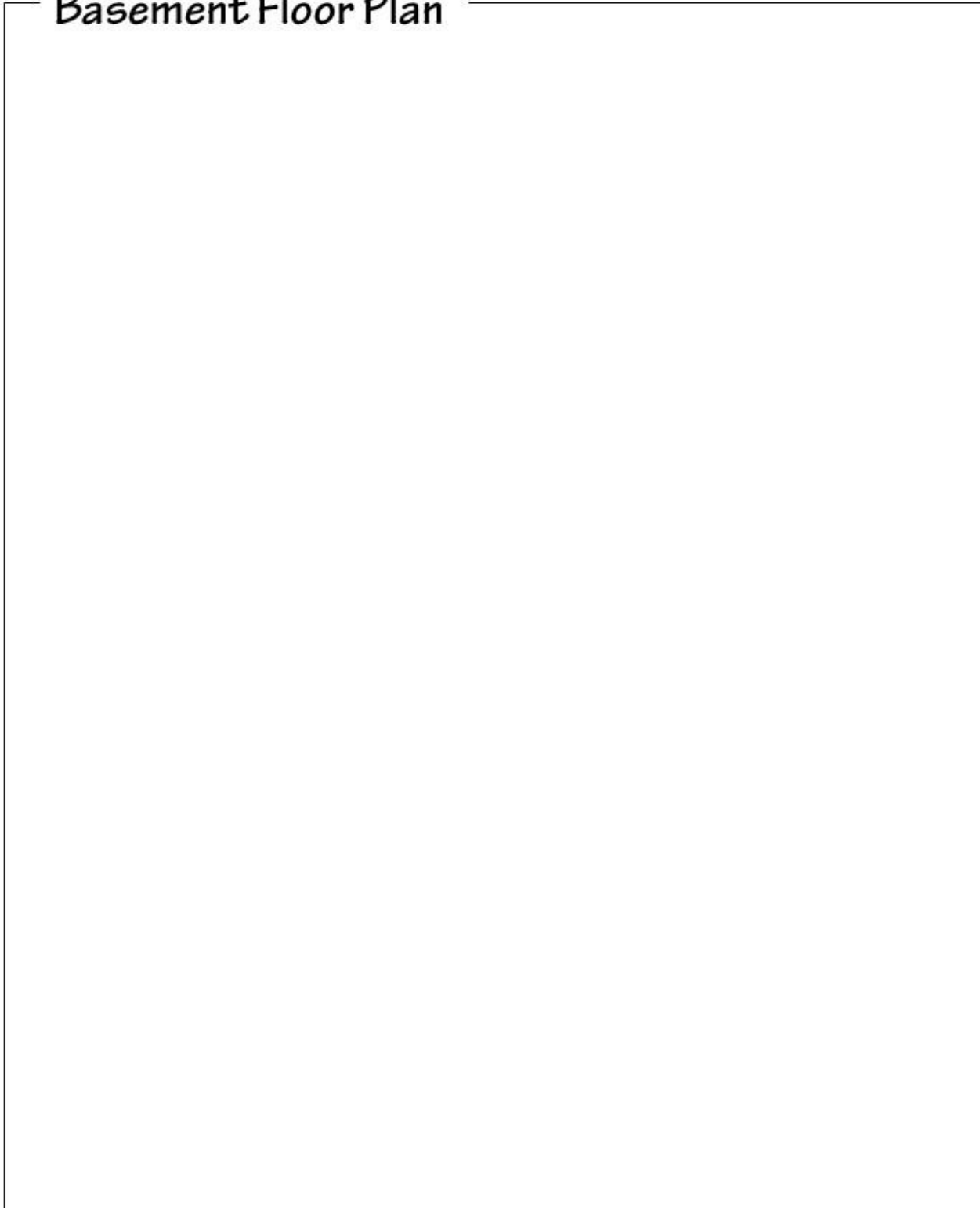

OCCUPANCY:
ADDRESS:

DATE:

Page ____ of
____ pages.

____ Floor Plan

OCCUPANCY:
ADDRESS:

DATE:

Page ___ of
___ pages.

___ Floor Plan

OCCUPANCY:
ADDRESS:

DATE:

Page ____ of
____ pages.

____ Floor Plan